

80W LED Flood Light Specification



Product Description

- * High pressure die casting housing ,anti-static powder painting.
- * High thermal conductive material and High efficiency cooling system .
- * High efficient LM80 approved Chips ensures excellent performance
- * Tempered glass front.
- * IP Rating: IP65

SPECIFICATION

Model No.	Watts (W)	Color Accuracy (CRI)	Light Output (lm)	Dimension(mm)	CCT (K)	Beam Angle	ETL	DLC
DJ-FL80W-3000K	80W	>80	>8800lm	L135x W115(mm)	3000K	120°	Y	Y
DJ-FL80W-4000K					4000K		Y	Y
DJ-FL80W-5000K					5000K		Y	Y

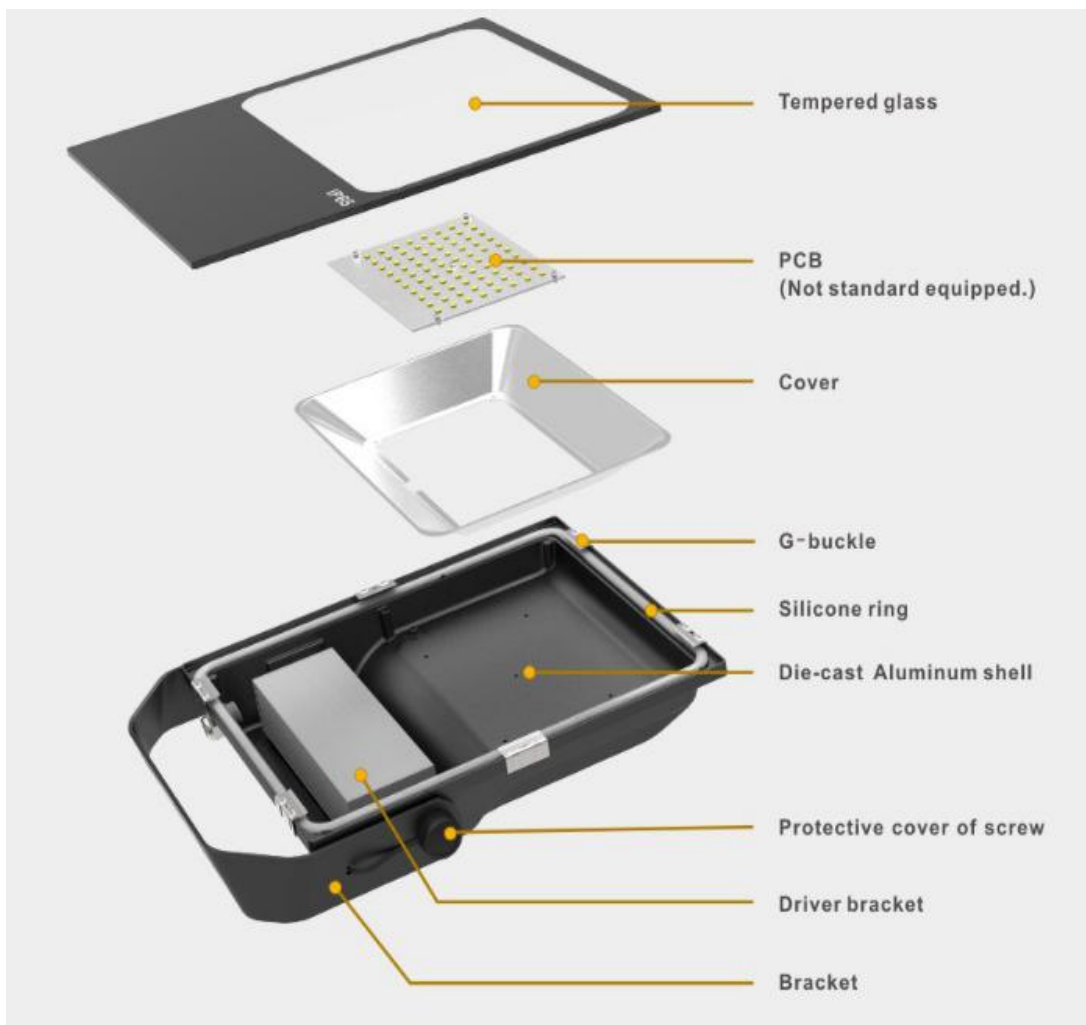

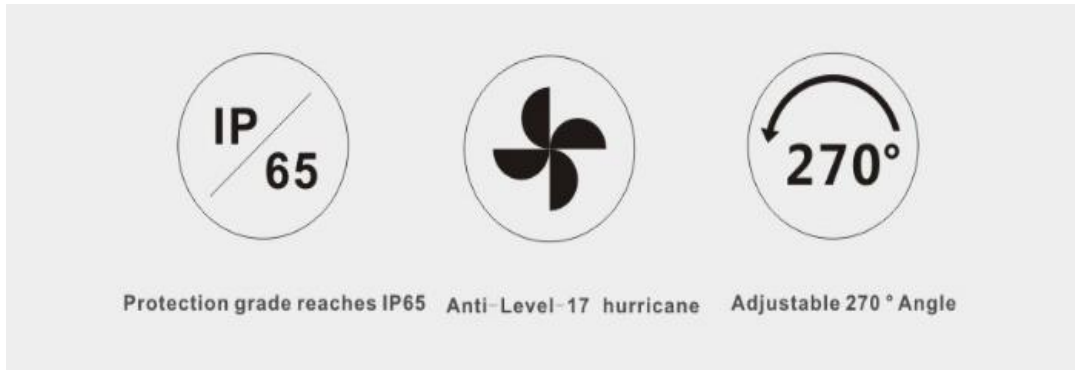

FIXTURE MOUNTING

U Bracket Mounting:

Follow Mounting directions as in fig.1

1. Please prepare all parts and repairs which the lighting needs.
2. Turn off the power before installation.
3. According to the construction drawing position, open holes and fix the U-bracket.
4. Connect driver to AC wires.
5. Turn on the power after confirmed ,the installation is complete.

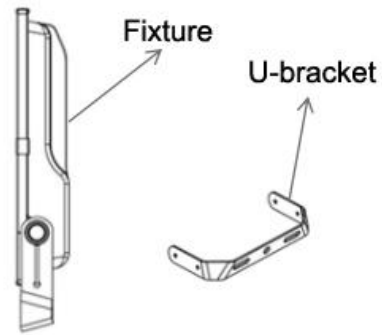

fig.1

Wiring

AC Input wires

Follow as in fig.2

- a) " brown" wire lead to the "L", " blue" wire lead to the "N", "green " wire lead to the "G".
- b) Input wiring connected to the power supply shall be carried out in accordance with the corresponding color correctly, and ensure the correct phase.



fig.2

APPLICATION

Widely used in shopping mall, exhibition hall, parking lot, playground, gymnasium, billboards, park, sculpture, national green lighting build building façade and public corridor, stair corridor and other indoor and outdoor lighting

